

Industry Acoustic System
IAS-MO 2000 Set

Instructions for use

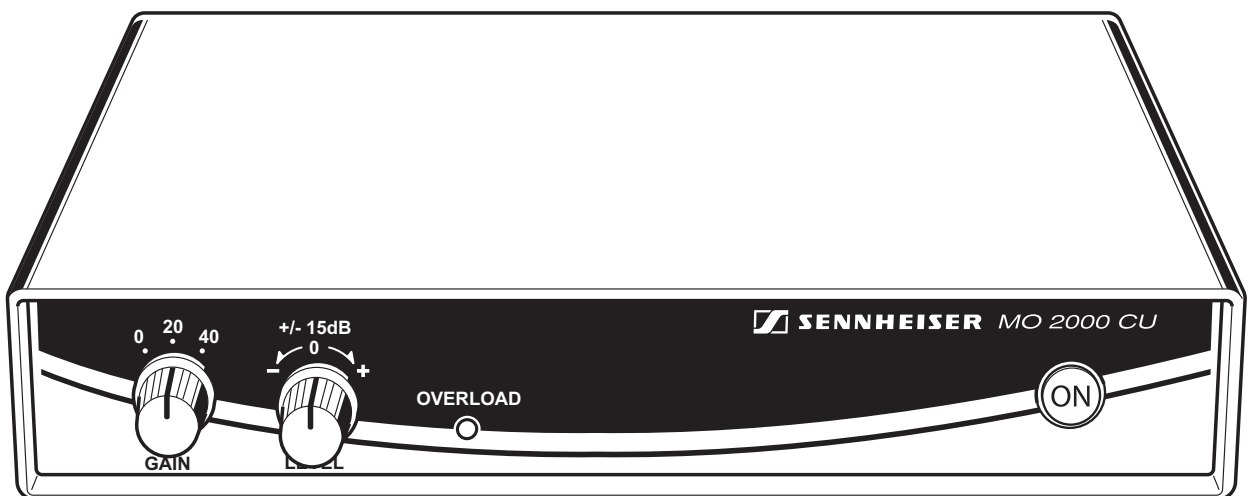
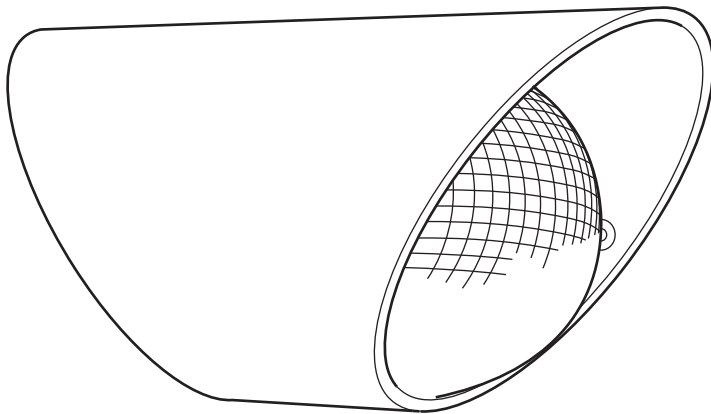

Contents

Safety instructions	2
IAS-MO 2000 Set	4
Delivery includes.....	5
IAS-MO 2000 Set	5
MZWW 2000	5
Product overview IAS-MO 2000 Set.....	6
Putting the system into operation	7
Setting up the device	7
Rack mounting	7
Connecting the mains unit	8
Connecting the amplifier	8
Connecting the optical microphone	9
Switching the central unit on/off	11
Adjusting the sensitivity	11
Overload indication	11
Disassembling the weather and wind protection	12
Accessories.....	12
Care and maintenance.....	13
Specifications	14
Connector assignment	15
Frequency response curve	15
Manufacturer Declarations	16

Safety instructions



This instruction manual contains important safety information.

Read this instruction manual.

Keep this instruction manual in a safe place. Always include this instruction manual when passing the system on to third parties.

Heed all warnings.

Follow all instructions.

WARNING: To reduce the risk of fire or electric shock, do not expose the device and the mains unit to rain or moisture.

Disconnect the mains connector from the wall socket to completely disconnect the device from the mains during lightning storms or when unused for long periods of time.

Use only the supplied mains unit.

Ensure that the mains unit is:

- always readily operable and easily accessible,
- properly plugged into the wall socket,
- only operated within the permissible temperature range (see “Specifications” on page 14),
- not covered or exposed to direct sunlight for longer periods of time in order to prevent heat accumulation.

Use of the MO 2000 CU central unit



The MO 2000 CU central unit has been designed for use with the MO 2000 H optical microphone.

To meet the requirement of the ATEX directive, the central unit must be installed and operated outside areas with potentially explosive atmospheres!

Use of the MO 2000 H optical microphone

When installed in the MZWW 2000 weather and wind protection, the MO 2000 H optical microphone meets the IP 54 standard for dust and moisture resistance. In combination with the MZWW 2000, the optical microphone is approved and permitted for:

- use in zone I explosive atmospheres
- use in potentially explosive atmospheres of group IIC and temperature class T6.

Rack mounting

When installing the device in a closed or multi-rack assembly, please consider that, during operation, the ambient temperature within the rack may significantly rise above room temperature. However, the ambient temperature within the rack must not exceed the temperature limit specified in the specifications.

When installing the device in a rack, take good care not to affect the ventilation required for safe operation or provide additional ventilation.

Make sure the mechanical loading of the rack is even to avoid a hazardous condition such as a severely unbalanced rack.

When installing the device in a closed or multi-rack assembly, please note that intrinsically harmless leakage currents of the individual devices may accumulate, thereby exceeding the allowable limit value. As a remedy, ground the rack via an additional ground connection.

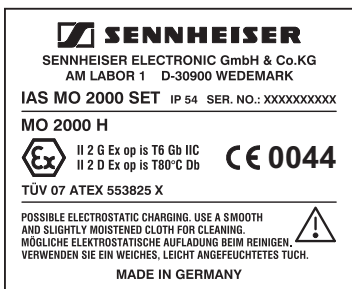

Operation

This device must be operated only from the type of power supply indicated on the type plate. Observe correct polarity!

Never push objects of any kind through openings of this device as they may touch dangerous voltage points or short-out parts that could result in fire or electric shock.

Ensure sufficient ventilation. Do not block any ventilation openings. Install in accordance with the manufacturer's instructions.

Do not install near any heat sources such as central heating radiators, electric heaters, stoves, or other devices that produce heat (e.g. amplifiers). Keep the device away from direct sunlight and similar sources of heat.

Only use attachments/accessories specified by Sennheiser.

Use the device in dry rooms only. Do not expose the device to dripping or splashing and ensure that no objects filled with liquids, such as vases or coffee cups, are placed on the device. Do not use the device near water or liquids.

Should a spillage occur, unplug the device and have it checked by a technician.

Service

No user serviceable parts inside! Do not attempt to service devices yourself as opening or removing covers may expose dangerous voltage or other hazards. If devices are opened by customers in breach of this instruction, the warranty becomes null and void.

Refer all servicing to qualified service personnel. Servicing is required if a device has been damaged in any way, such as mains cable or plug damage, liquid has been spilled, objects have fallen inside, the device has been exposed to rain or moisture, does not operate properly or has been dropped.

Intended use of the device

"Intended use" means that the device should be used within the operating conditions and limitations described in this instruction manual.

"Improper use" means using the device other than as described in this instruction manual, or under operating conditions which differ from those described herein.

IAS-MO 2000 SET

The IAS-MO 2000 Set system consists of the following main components:

- 1 MO 2000 Set optical microphone system
- 1 MZWW 2000 weather and wind protection

The IAS-MO 2000 Set system meets the requirements of the ATEX directive.

The MO 2000 H optical microphone consists of an opto-acoustic microphone head which is fitted with a fixed 3 m double fiber optic cable. The fiber optic cable is connected to the MO 2000 CU central unit. Power is supplied via an external wide voltage range power supply unit.

The MO 2000 H is an omni-directional microphone designed for picking up airborne sound. The components of the MO 2000 H microphone head (outside dimensions: 1/2 inch) are made of plastic suitable for permanent stationary use in areas where aggressive substances (gases, salts, moisture) or radiation are present. All components of the MO 2000 H microphone head are metal-free, including the fiber optic cable feed.

The main areas of application of the optical microphone are acoustic measurement and communication tasks in industrial environments and EMC-sensitive areas as well as medical magnetic resonance imaging and magnetoencephalographic measurement (MEG). Other applications are to be found in the field of non-detectable acoustic surveillance.

Delivery includes

IAS-MO 2000 Set

- 1 MO 2000 H optical microphone with 3 m fiber optic cable
- 1 MO 2000 CU central unit
- 1 mains unit with different country adapters
- 1 GA 2 rack adapter
- 1 carrying case
- 1 instruction manual

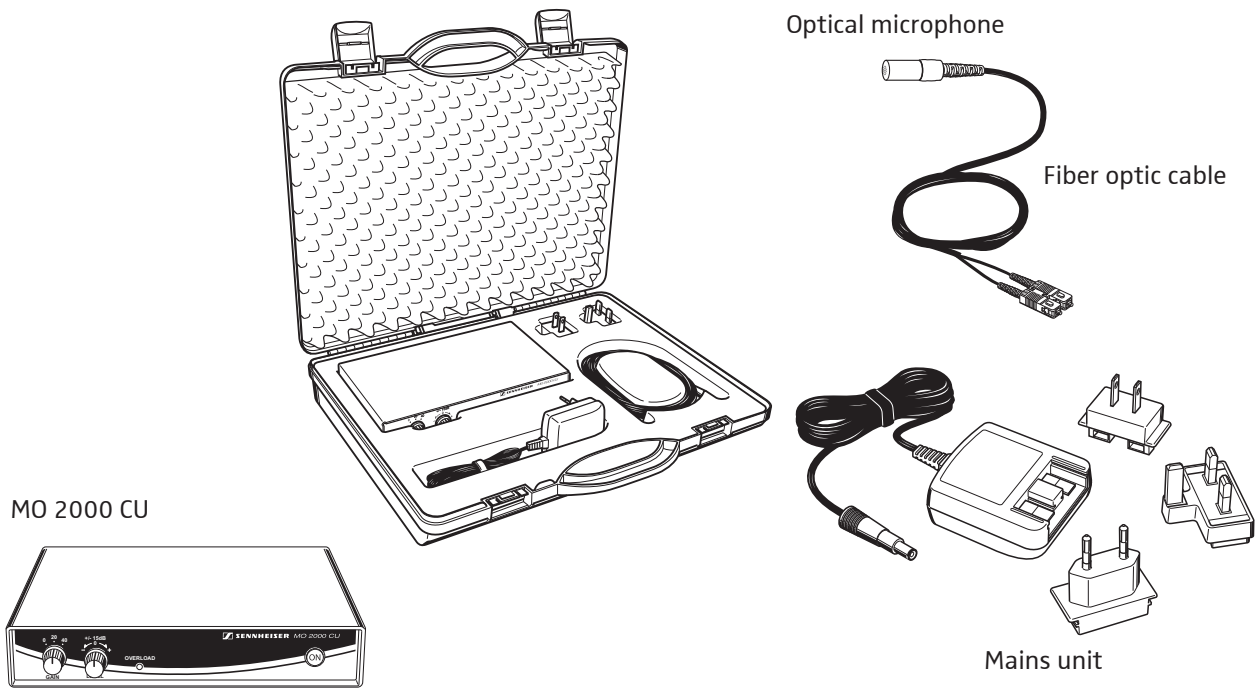

MZWW 2000

- 1 pipe
- 1 SCRJ-GOF socket (inside the MZWW 2000)
- 1 cover with gasket
- 1 plate/mounting frame
- 1 SCRJ-HCS socket (fiber optic connector set)
- 1 windshield basket
- 1 MZQ 2000 microphone clamp

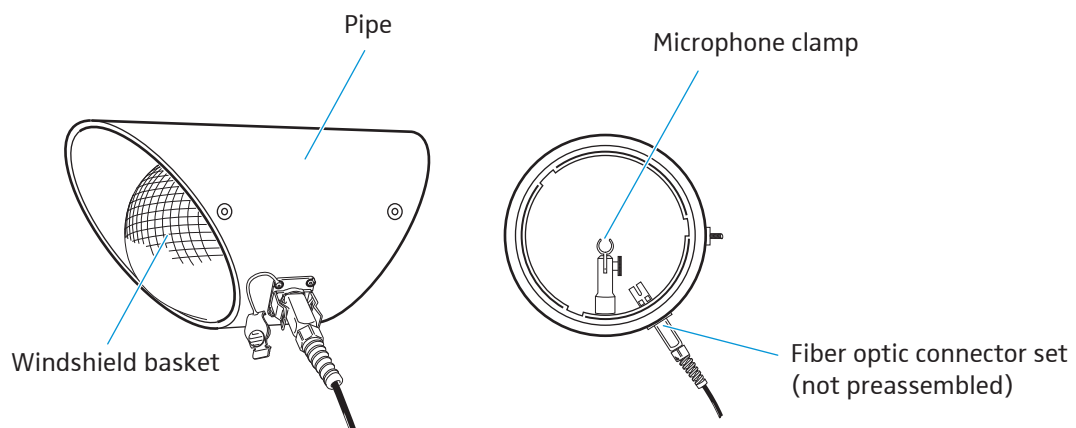

Product overview IAS-MO 2000 Set

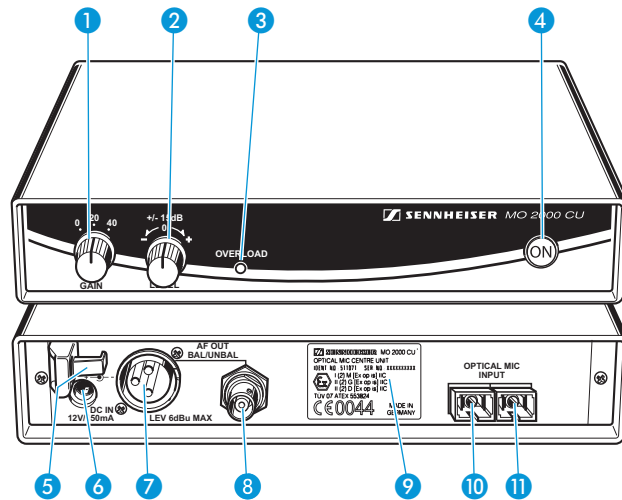

- 1 Gain switch (coarse adjustment)
- 2 Level control (fine adjustment), with 0 dB mark
- 3 OVERLOAD LED
- 4 ON/OFF button
- 5 Cable grip for power supply DC cable
- 6 DC socket for connection of power supply unit (DC IN)
- 7 Audio output (AF OUT BAL), XLR-3M, balanced
- 8 Audio output (AF OUT UNBAL), BNC socket, unbalanced
- 9 Type plate
- 10 SC optical input for microphone
- 11 SC optical output for microphone

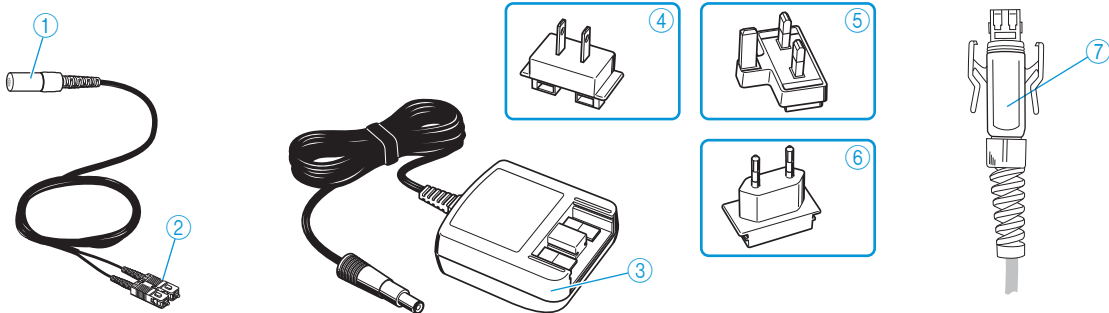

- 1 Optical microphone
- 2 SC duplex connector
- 3 Mains unit
- 4 US adapter
- 5 UK adapter
- 6 EU adapter (preassembled)
- 7 Fiber optic connector

Putting the system into operation

CAUTION! Risk of staining of furniture surfaces!

Some furniture surfaces have been treated with varnish, polish or synthetics which might cause stains when they come into contact with other synthetics. Despite a thorough testing of the synthetics used by us, we cannot rule out the possibility of staining.

- ▶ Do not place the central unit on delicate furniture surfaces.

You can set up the device on an even surface or mount it into a 19" rack.

Note:

Do not fit the rubber feet when rack mounting the device.

Setting up the device

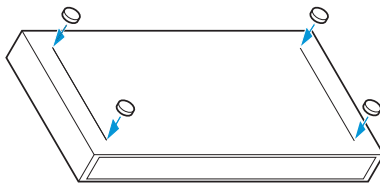

To ensure that the device cannot slip on the surface on which it is placed, fix the supplied four self-adhesive soft rubber feet to the base of the device.

- ▶ Ensure that the base of the device is clean and free from grease before fitting the rubber feet.
- ▶ Fix the rubber feet to the base of the device by peeling off the backing paper and fitting them as shown.

Rack mounting

CAUTION! Danger of heat damage!

When installing the device in a closed or multi-rack assembly, please consider that, during operation, the temperature within the rack may rise significantly.

- ▶ Make sure not to affect the ventilation required for safe operation or provide additional ventilation.

CAUTION! Danger of electric shock!

When installing the device in a closed or multi-rack assembly, please note that intrinsically harmless leakage currents of the individual devices may accumulate, thereby exceeding the allowable limit value.

- ▶ Ground the rack via an additional ground connection.

For mounting two central units into a 19" rack, you require the GA 2 rack adapter. The GA 2 rack adapter consists of:

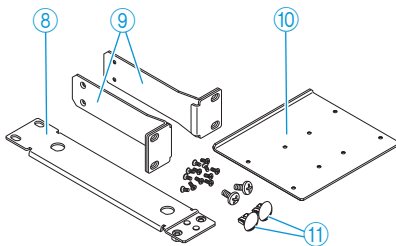

- 1 blanking plate ⑧
- 2 rack mount "ears" ⑨
- 1 jointing plate ⑩
- 2 blanking plugs ⑪ for closing off unused BNC holes
- 12 recessed head screws M 3x6
- 2 recessed head screws M 6x10

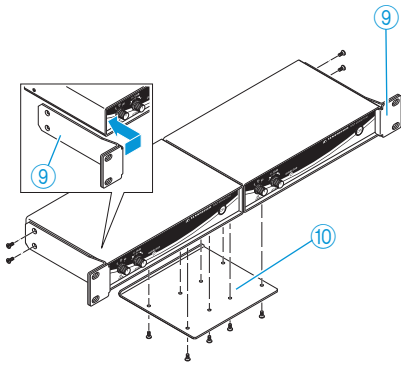

To mount **two** central units into a rack:

- ▶ Place the two central units side by side upside-down onto a flat surface.
- ▶ Align the jointing plate (10) over the holes in the bottom sides of the central units.
- ▶ Secure the jointing plate (10) to the central units using eight of the supplied recessed head screws (M 3x6).
- ▶ Hook the two rack mount "ears" (9) the front panels of the central units.
- ▶ Secure the rack mount "ears" to the central units using two of the supplied recessed head screws (M 3x6) respectively.
- ▶ Slide the central units into the 19" rack.
- ▶ Secure the rack mount "ears" to the rack.

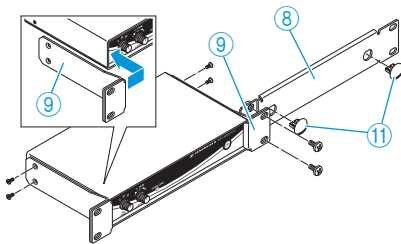

To mount only **one** central unit into a rack:

- ▶ Hook the two rack mount "ears" (9) to the front panel of the central unit.
- ▶ Secure the rack mount "ears" to the central unit using two of the supplied recessed head screws (M 3x6) respectively.
- ▶ Secure the blanking plate (8) to one of the rack mount "ears" (9) using two of the supplied recessed head screws (M 6x10).
- ▶ If you are not front mounting the BNC output connector, insert the two blanking plugs (11) into the holes of the blanking plate.
- ▶ Slide the central unit into the 19" rack.
- ▶ Secure the rack mount "ears" to the rack.

Connecting the mains unit

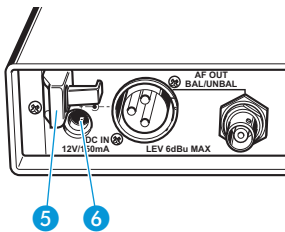

- ▶ Connect the supplied mains unit to the socket (6) (DC IN). Use the cable grip (5) to secure the power supply DC cable.
- ▶ Connect the suitable adapter to the mains unit (3).
- ▶ Connect the mains unit (3) to the mains.
The device switches on automatically.

Connecting the amplifier

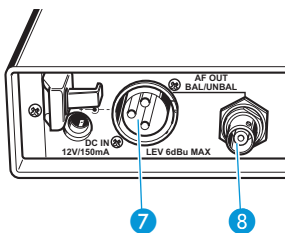

The audio outputs are available as a balanced XLR-3M output (7) and an unbalanced BNC output (8), allowing you to simultaneously connect two devices (amplifier, etc.). Both outputs deliver the same output voltage, are short-circuit proof and decoupled from each other.

- ▶ Connect the amplifier/mixing console to the balanced XLR-3M output (7) or the unbalanced BNC output (8).
For details on balanced or unbalanced connection, see "Connector assignment" on page 15.

Connecting the optical microphone

CAUTION! Risk of damage to fiber optic cable!



Fiber optic cable must not be bent like conventional cable!

- ▶ When installing fiber optic cable, make sure not to bend it beyond a **bend radius** of 50 mm.

CAUTION! Signal loss!



A wrong polarity will reduce the signal strength.

- ▶ When connecting the microphone, please observe correct polarity.

CAUTION! Liquids can damage the electronics!



Liquids entering the housing of the device can cause a short-circuit and damage the electronics.

- ▶ For outdoor applications, use only a suitable cable together with the supplied fiber optic connector ⑦.

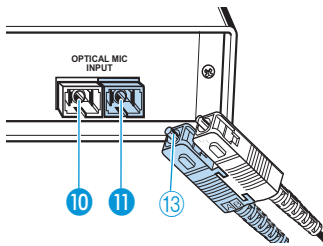

- ▶ Before connecting the optical microphone, remove the protection caps from the microphone connections ⑩ and ⑪ of the central unit. Keep the protection caps in a safe place for reuse during transport or storage. They protect the microphone connections against dirt.
- ▶ Connect the duplex connector of the professionally ready-made cable to the microphone connections ⑩ and ⑪ of the central unit. Please observe the correct insertion direction of the connector. The duplex connector is connected the correct way round when the label ⑬ on the connector is facing downwards as shown.
- ▶ Connect the fiber optic connector ⑦ with the professionally ready-made cable to the weather and windshield.

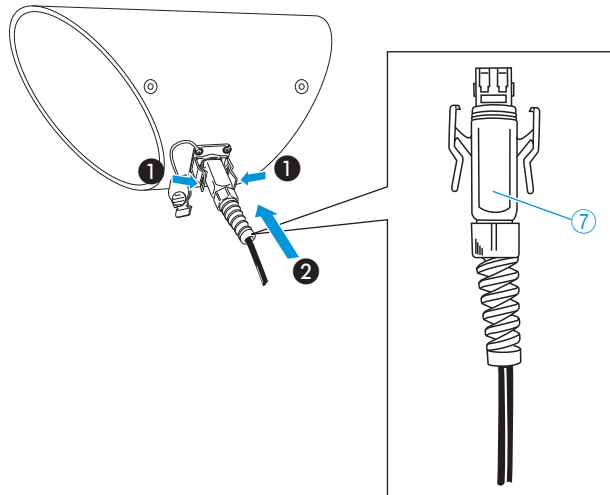

Note:

Make sure that at least 15 cm of the fiber optic cable, starting from the radiation source, is outside the explosion-hazardous area.

Connecting the optical microphone to the weather and windshield

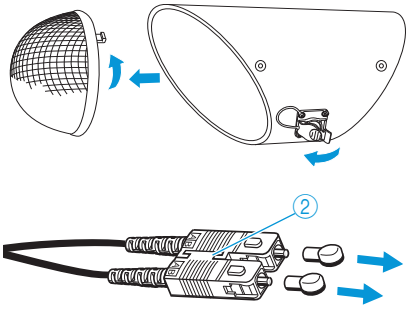

- ▶ Remove the windshield basket and open the flap in the pipe as shown.

- ▶ Remove the protection caps from the connectors of the fiber optic cable ②.
- ▶ Push down the plastic housing on an even base until the housing detaches from the connectors with an audible click.

Note:

Use a solid, even and clean base (e.g. a sheet of paper) in order to not damage the tips of the connectors.

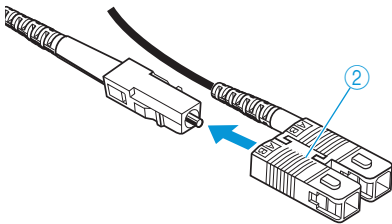
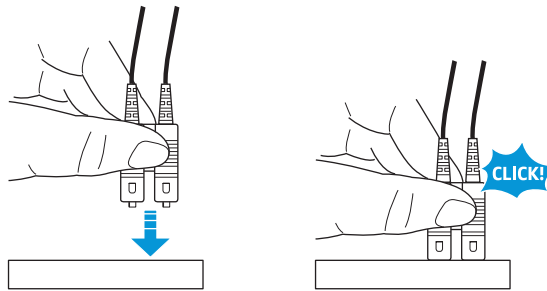

- ▶ Pull the connectors of the fiber optic cable ② one after the other out of the plastic housing.
- ▶ Remove the protection caps of the SCRJ-GOF socket inside the weather and windshield.
- ▶ Observe correct polarity of the professionally ready-made cable, i.e. insert the connectors of the fiber optic cable ② into the SCRJ-GOF socket so that the polarizing keys point outward. When the connectors are inserted correctly, the polarizing keys lock into place with an audible click (see diagram on page 9).
- ▶ Lay the remaining microphone cable around the microphone clamp. Please note that fiber optic cable must not be bent like conventional cable. Make sure not to bend it beyond a bend radius of 50 mm.
- ▶ Insert the optical microphone ① into the microphone clamp ⑫.

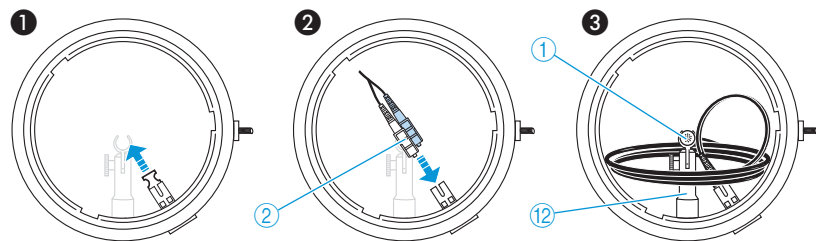

Switching the central unit on/off

After connection to the mains, the device switches on automatically and the ON button 4 lights up.

- ▶ Press the ON button 4 to switch the MO 2000 CU central unit on or off.

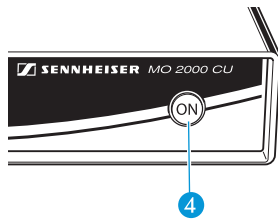

Note:

If the power supply is interrupted for several seconds (e.g. due to a power failure), the device switches on automatically even if it was switched off before.

Adjusting the sensitivity

With the microphone connected and both the gain switch 1 and the level control 2 set to 0 dB, the specified sensitivity (mV/Pa) is obtained.

- ▶ Use the gain switch 1 to increase the output voltage level by 20 dB (tenfold increase) or 40 dB (hundredfold increase).
- ▶ Use the level control 2 to steplessly adjust the output voltage level between -15 dB and +15 dB.

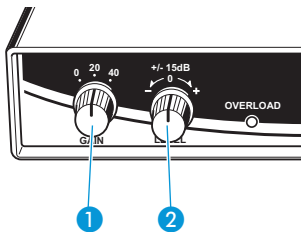

Overload indication

The OVERLOAD LED 3 indicates both positive and negative voltage peaks.

If the OVERLOAD LED 3 lights up:

- ▶ Use the gain control 1 and/or the level control 2 to reduce the output voltage level so that the OVERLOAD LED 3 no longer lights up.

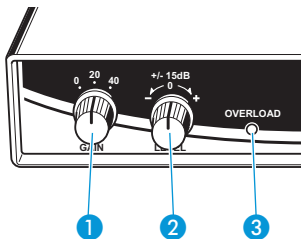

Disassembling the weather and wind protection

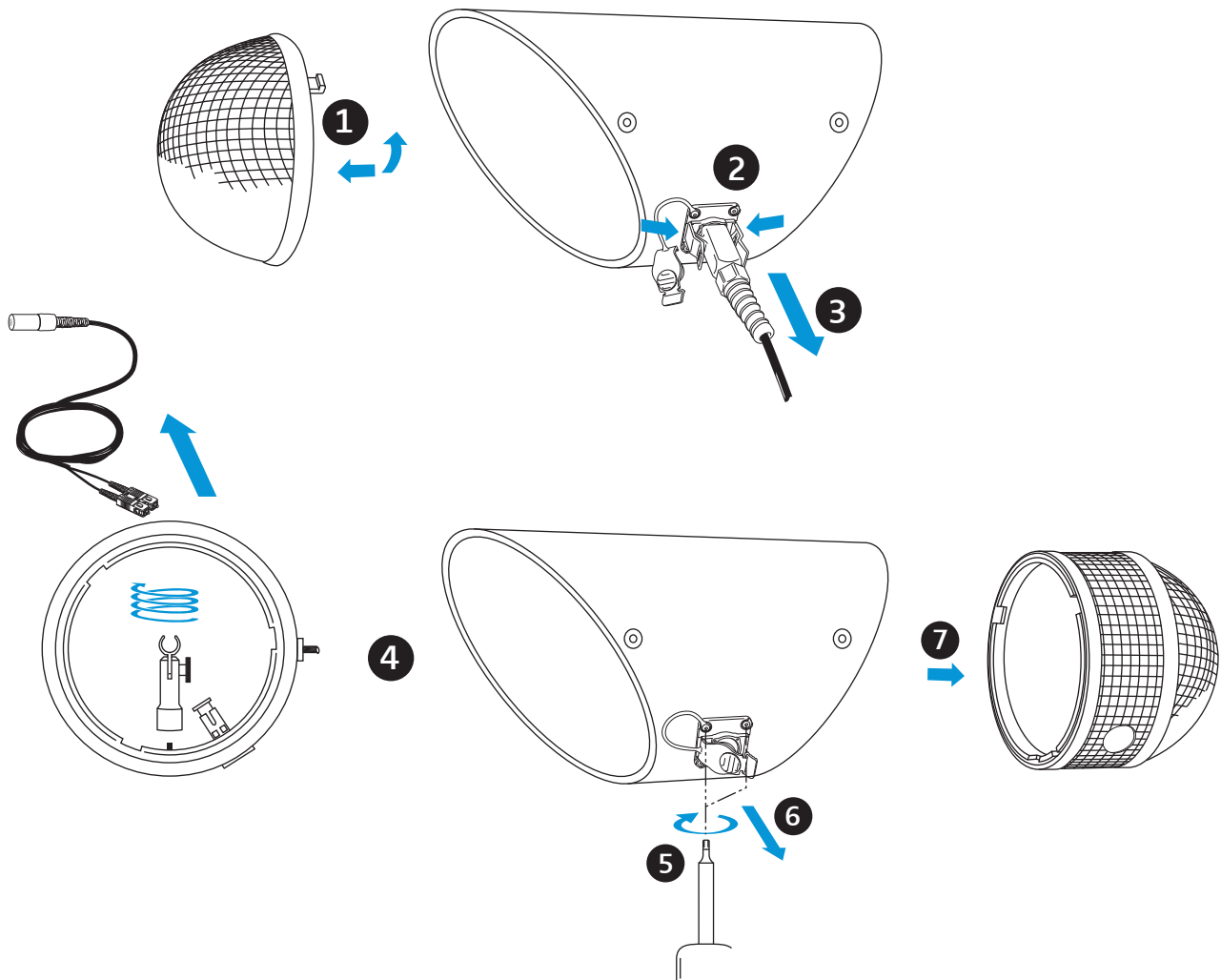

Accessories

Cat.-No.	Accessory
009823	GA 2 rack adapter
525700	MO 2000 H optical microphone
525701	MO 2000 CU central unit
525702	Pipe
522170	SCRJ-GOF socket (inside the MZWW 2000)
522168	Cover with gasket
522169	Plate/mounting frame
522176	SCRJ-HCS socket (fiber optic connector set)
067510	Mains unit
524601	Windshield basket
502186	MZQ 2000 microphone clamp
511999	Carrying case with foam insert
516503	Instruction manual

Care and maintenance

WARNING! Danger to life!



Repairs to explosion-proof components are not allowed. If you repair explosion-proof components yourself, this presents an explosion hazard.

- ▶ Refer all repairs to the manufacturer.
-

CAUTION! Liquids can damage the electronics of the MO 2000 CU central unit!



Liquids entering the housing of the device can cause a short-circuit and damage the electronics.

- ▶ Keep all liquids far away from the device.
 - ▶ Before cleaning, disconnect all devices from the mains.
-

WARNING! Explosion hazard!



When cleaning the weather and wind protection, electrostatic charges can be generated.

- ▶ Use only a soft, slightly damp cloth to clean the weather and wind protection.
 - ▶ Do not use any solvent-containing products for cleaning.
-

To clean the MO 2000 CU central unit:

- ▶ Before cleaning, disconnect the device from the mains.
- ▶ Use a soft, dry cloth to clean the device.

To clean the MZWW 2000 weather and wind protection:

- ▶ Use a soft, slightly damp cloth to clean the weather and wind protection.

Specifications

MO 2000 CU central unit

Housing	$1/2$ 19" metal housing
Front panel connections and controls	ON/OFF button with operation indicator, OVERLOAD LED, gain control (coarse adjustment), level control (fine adjustment), with 0 dB mark
Rear panel connections and controls	DC socket for connection of mains unit, SC duplex input for microphone, XLR socket, balanced BNC socket
Power supply	mains unit with country adapter 100-240 V AC to 12 V DC, 5.4 W
Power consumption of CU	1.5 W at 12 V DC
Current consumption	120 mA
Gain	steplessly adjustable between ± 15 dB, three settings: 0 dB, +20 dB, +40 dB
AF output level	15 mV/Pa (level control set to central position, gain switch set to 0 dB)
Output impedance	approx. 330 Ω unbalanced/660 Ω balanced
Max. output level	1.55 V
Operating temperature range	0°C to +40°C
Storage temperature range	-20°C to +70°C

MO 2000 H optical microphone

Design	MO 2000 H microphone head with 3 m fiber optic cable
Pick-up pattern	omni-directional
Frequency response	20 Hz to 40 kHz (± 6 dB)
Sensitivity	15 mV/Pa
S/N ratio at 1 Pa SPL	> 50 dB(A)
Max. SPL	134 dB
Operating temperature range	-10°C to +70°C
Storage temperature range	-20°C to +70°C
MO 2000 H optical microphone together with MZWW 2000	complies with the IP 54 standard

Fiber optic extension cable (optional)

Interface	SC
Design	multimode 200/230 μm
Cable loss	approx. 3–4 dB per 100 m

Optical transducer (optional)

Interface	socket/socket
Design	type SC
Coupling losses	5–6 dB per coupling pair

AF cable

Design	balanced microphone cable with shielding
--------	------------------------------------------

Connector assignment



DC connector for mains unit

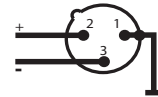

XLR-3F connector, balanced

Frequency response curve

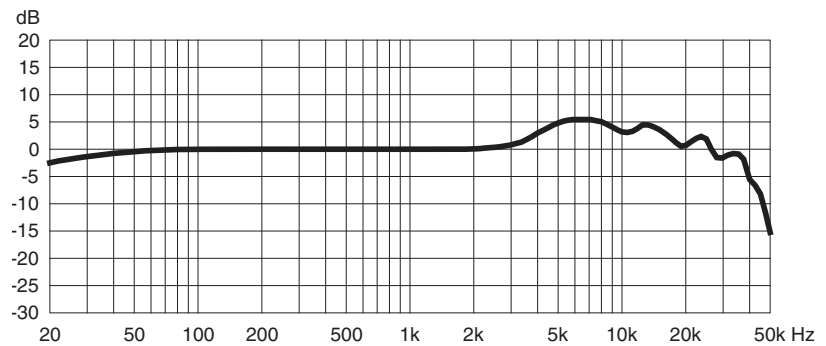

Manufacturer Declarations

Warranty

Sennheiser GmbH & Co. KG gives a warranty of 24 months on this product.

For the current warranty conditions, please visit our web site at www.sennheiser.com or contact your Sennheiser partner.

CE Declaration of Conformity

CE 0044

This equipment is in compliance with the essential requirements and other relevant provisions of Directives 94/9/EC, 2004/108/EC, and 2006/95/EC.

The IAS MO 2000 Set microphone system complies with the requirements on intrinsically safe optical radiation equipment according to EN 60079-0: 2004 and EN 60079-28:2007. The devices are accompanied by the type-examination certificates TÜV 07 ATEX 553824 and TÜV 07 ATEX 553825X.

Statements regarding FCC and industry Canada

This device complies with Part 15 of the FCC Rules and with RSS-210 of Industry Canada. Operation is subject to the following two conditions: (1) this device may not cause harmful interference, and (2) this device must accept any interference received, including interference that may cause undesired operation.

Changes or modifications made to this equipment not expressly approved by Sennheiser electronic Corp. may void the FCC authorization to operate this equipment.



Sennheiser electronic GmbH & Co. KG

Am Labor 1

30900 Wedemark, Germany

Phone +49 (5130) 600 0

Fax +49 (5130) 600 300

www.sennheiser.com

Printed in Germany

Publ. 08/08

524194/A01